

DCX SPLICE CASSETTE PART NUMBER DESCRIPTION

PART NUMBER EXAMPLE: FC3D06LDFP
BROKEN DOWN PART NUMBER :

FC

3

D

06

LD

FP

FIBER TYPE	
3	OM3
4	OM4
S	OS2

PRODUCT FAMILY	
D	DCX



PORT COUNT (PATCH SIDE)	
06	6 PORTS
12	12 PORTS

CONNECTOR (PATCH SIDE)	
LC TYPE	
LD	LC DUPLEX
LA	LC DUPLEX/APC
SC TYPE	
SD	SC DUPLEX
SA	SC DUPLEX/APC

FEATURES	
FP	250um COLOR CODED PIGTAILS
FS	SPLICING
FM	250um MASS FUSION PIGTAILS

OPTIONAL NUMBER CONFIGURATIONS

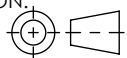
ADAPTER COLOR	
B	BLUE (TYP. OS2/UPC)
G	GREEN (TYP.OS2/APC)
A	AQUA (TYP.OM3)
E	ERIKA V. (TYP. OM4)

ORIENTATION:			
TITRE / TITLE:			
DCX SPLICE CASSETTE			
PROPRIÉTÉ INTELLECTUELLE L'information contenue dans ce document est la propriété de BELDEN Inc. PROPRIETARY INFORMATION The information contained in this document is the property of BELDEN INC.	FORMAT SIZE	NO DESSIN / DWG. NO.	REV
	A	BELDEN-620	A0
	ÉCHELLE SCALE: 1:2	MASSE WEIGHT:	SHEET 1 OF 5



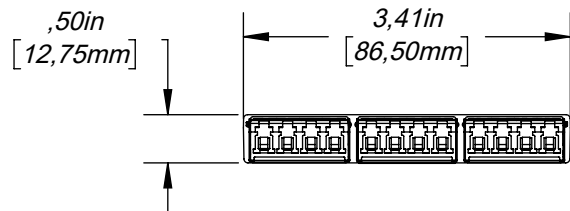
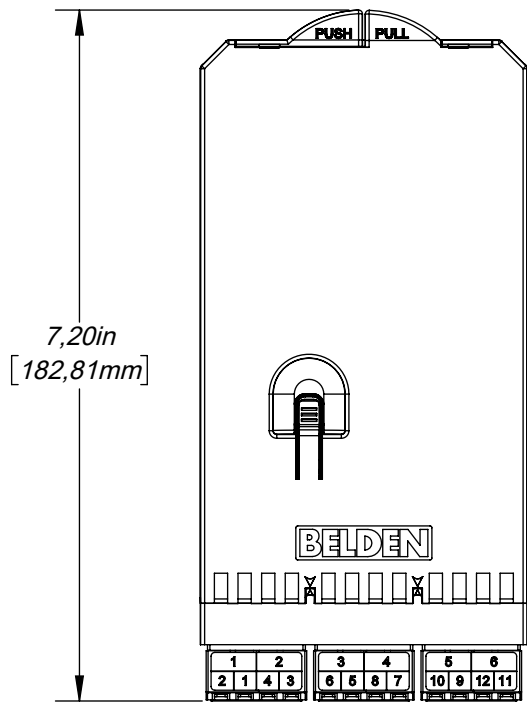

PRODUCT FAMILY : DCX SPLICE CASSETTES LC-DUPLEX (6P-12F)
FC_D06L_F_

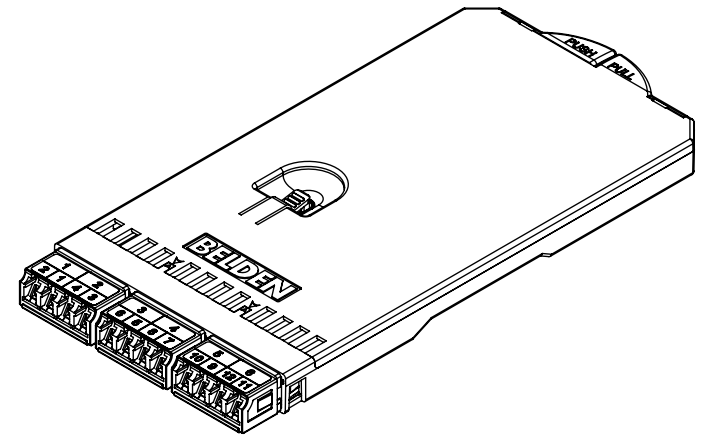

ORIENTATION:		BELDEN SENDING ALL THE RIGHT SIGNALS™
--------------	--	---

TITRE / TITLE:
DCX SPLICE CASSETTE

PROPRIÉTÉ INTELLECTUELLE L'information contenue dans ce document est la propriété de BELDEN Inc. PROPRIETARY INFORMATION The information contained in this document is the property of BELDEN INC.	FORMAT SIZE A	NO DESSIN / DWG. NO.	REV A0
	ÉCHELLE SCALE: 1:2	MASSE WEIGHT:	SHEET 2 OF 5

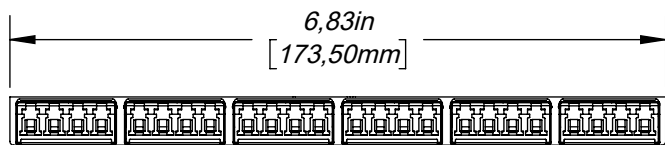
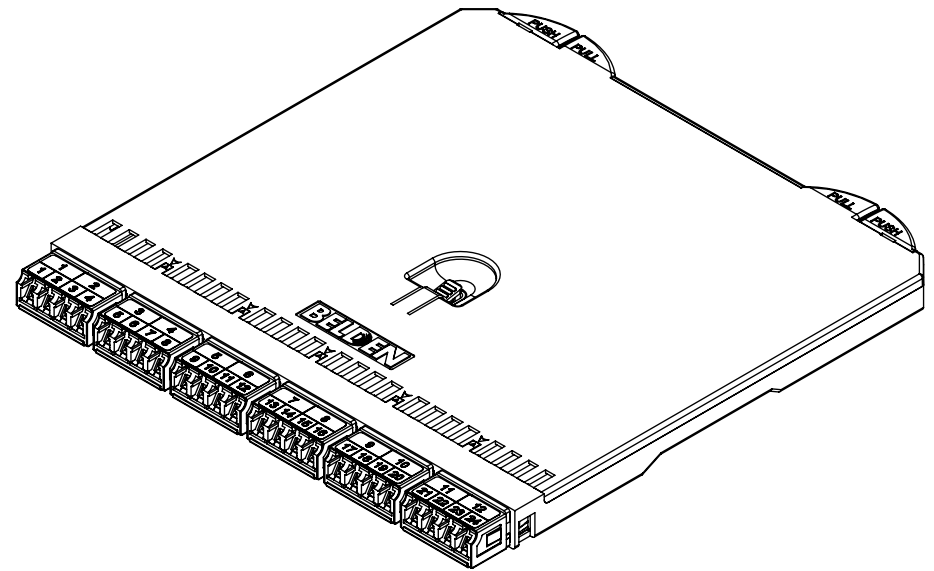
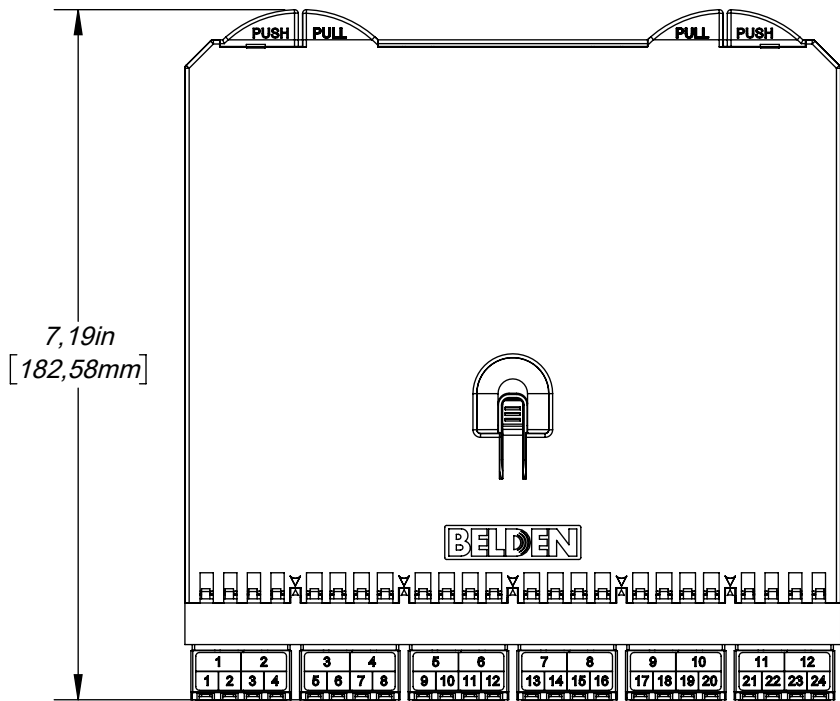

PRODUCT FAMILY: DCX SPLICE CASSETTE LC (6P-24F)
FC_D06L_F_

ORIENTATION:

BELDEN
SENDING ALL THE RIGHT SIGNALS™

TITRE / TITLE:
DCX SPLICE CASSETTE

PROPRIÉTÉ INTELLECTUELLE L'information contenue dans ce document est la propriété de BELDEN Inc. PROPRIETARY INFORMATION The information contained in this document is the property of BELDEN INC.	FORMAT SIZE A	NO DESSIN / DWG. NO.	REV A0
	ÉCHELLE SCALE: 1:2	MASSE WEIGHT:	SHEET 3 OF 5

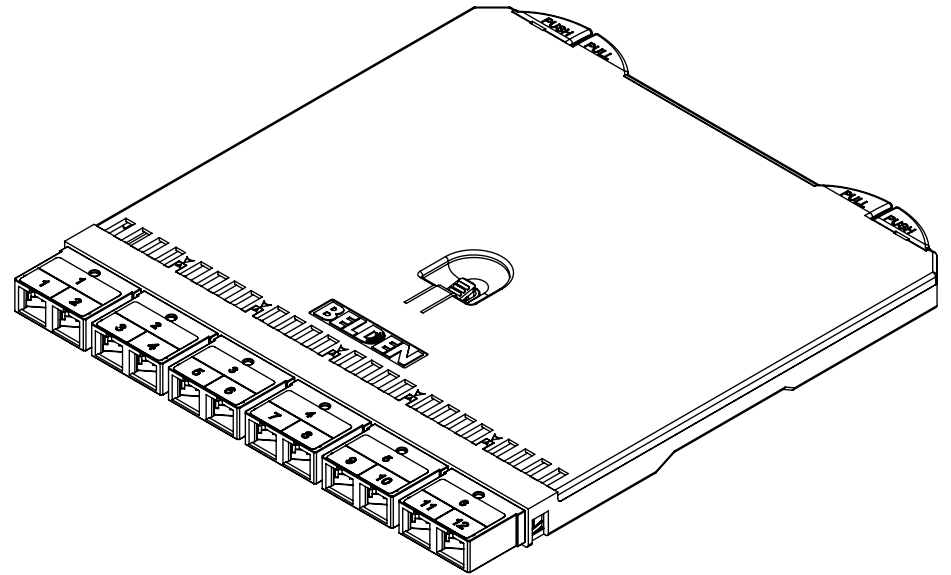
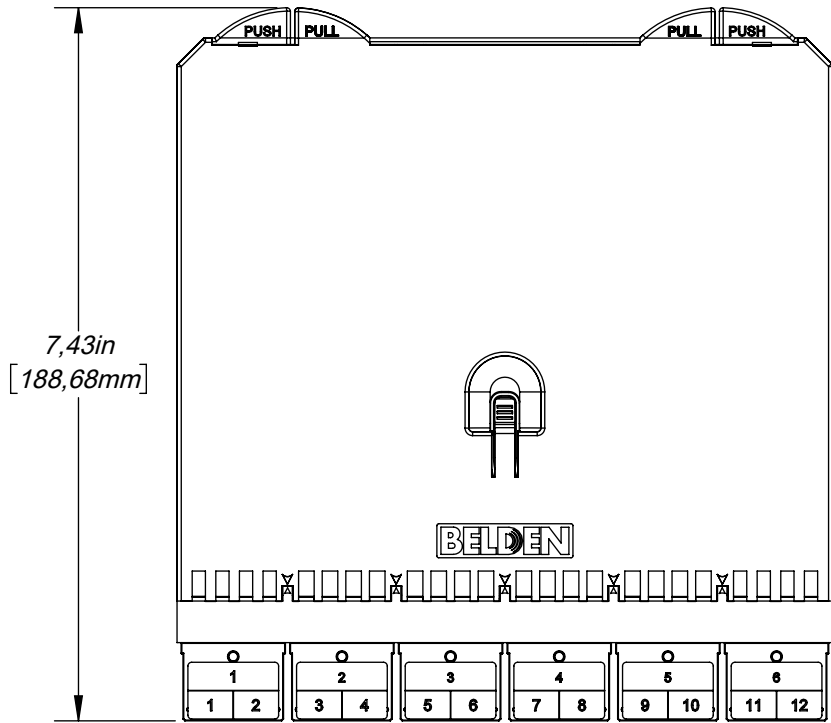

PRODUCT FAMILY: DCX SPLICE CASSETTE SC (6P-12F)
FC_D06S_F_



ORIENTATION:

BELDEN
SENDING ALL THE RIGHT SIGNALS™

TITRE / TITLE:
DCX SPLICE CASSETTE

PROPRIÉTÉ INTELLECTUELLE L'information contenue dans ce document est la propriété de BELDEN Inc. PROPRIETARY INFORMATION The information contained in this document is the property of BELDEN INC.	FORMAT SIZE A	NO DESSIN / DWG. NO.	REV A0
	ÉCHELLE SCALE: 1:2	MASSE WEIGHT:	SHEET 4 OF 5

FEATURES AVAILABLE FOR SPLICE CASSETTE

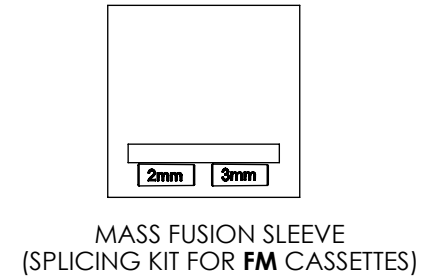
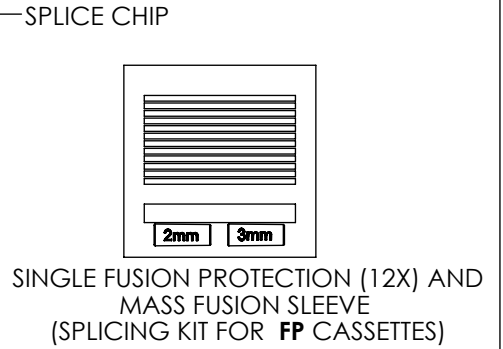
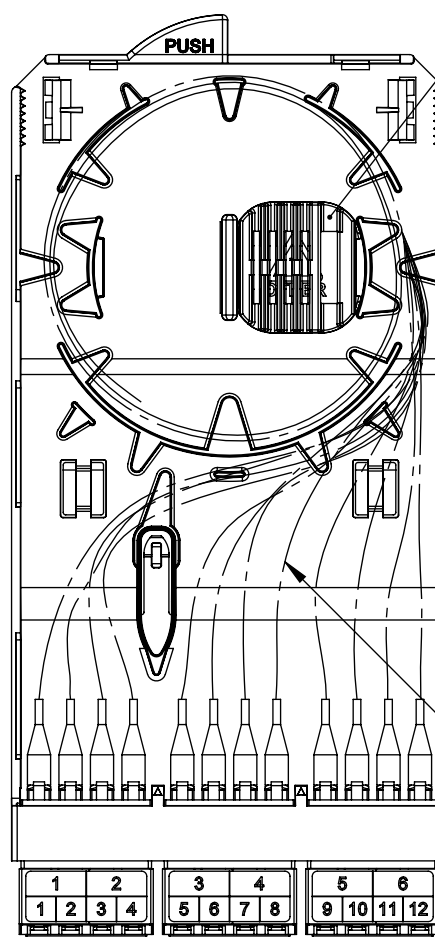
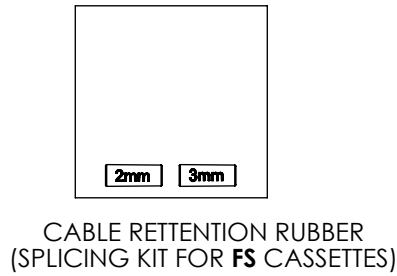
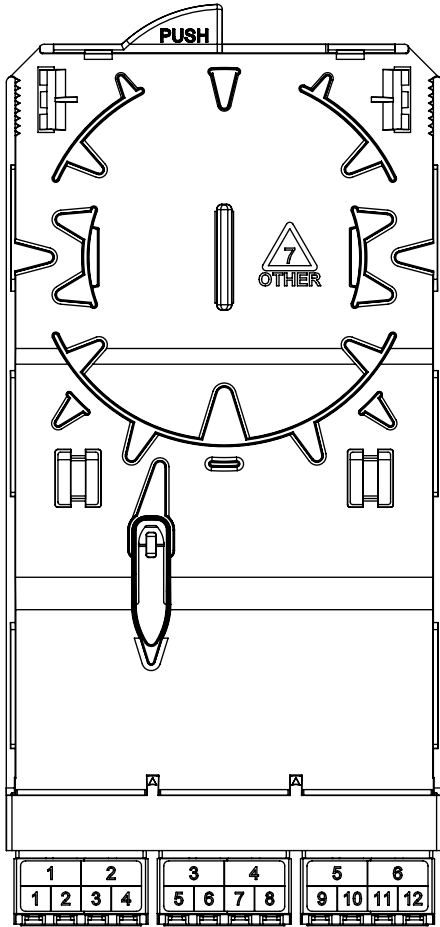

250 µm PIGTAILS PRELOADED:
- REGULAR FOR **FP** CASSETTES
- RIBBONIZED FOR **FM** CASSETTES

PRODUCT FAMILY : DCX SPLICE CASSETTES LC-DUPLEX (3P-12F)
FC_D06LDFS WITH SPLICING KIT SHOWN

PRODUCT FAMILY : DCX SPLICE CASSETTES
LC-DUPLEX (3P-12F)
FC_D06LDFFP AND FC_D06LDFM WITH SPLICING
KIT SHOWN

ORIENTATION:  **BELDEN**
SENDING ALL THE RIGHT SIGNALS™

TITRE / TITLE:
DCX SPLICE CASSETTE

PROPRIÉTÉ INTELLECTUELLE
L'information contenue dans ce document est la propriété de BELDEN Inc.
PROPRIETARY INFORMATION
The information contained in this document is the property of BELDEN INC.

FORMAT SIZE A	NO DESSIN / DWG. NO.	REV A0
-------------------------	----------------------	------------------

ÉCHELLE SCALE: 2:3	MASSE WEIGHT:	SHEET 5 OF 5
--------------------	---------------	--------------